

# Replacement Parts

## Passive and Active Probe General Replacement Parts

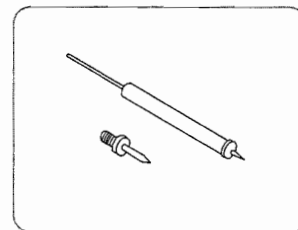
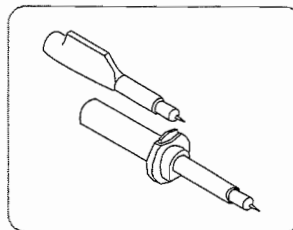
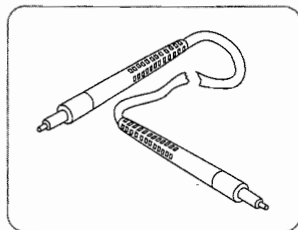
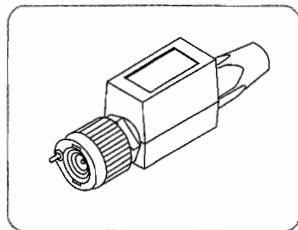

### ► Passive and Active Probe General Replacement Parts

Probe	Length (m)	Connector/Comp.Box	Probe Cable	Probe Head	Probe Tip/Hybrid Tip
P6101B	2	N/A	N/A	N/A	131-4997-01*2
P6102A	2	206-0352-00	174-0976-00	N/A	N/A
P6103B	2	N/A	N/A	N/A	131-4997-01*2
P6105A	1	206-0331-00	174-0975-00	206-0328-00	206-0336-01*2
	2	206-0334-00	174-0976-00	206-0301-00	206-0337-01*2
	3	206-0320-02	174-0977-00	206-0302-00	N/A
P6106A	1	206-0313-01	174-0975-00	206-0328-00	206-0336-01*2
	2	206-0319-01	174-0976-00	206-0301-00	206-0337-01*2
	3	206-0320-01	174-0977-00	206-0302-00	N/A
P6107A	2	N/A	174-0976-00	206-0217-02	206-0339-04*2
P6108A	1	206-0332-01	174-0975-00	206-0303-00	206-0336-01*2
	2	206-0318-02	174-0976-00	N/A	206-0337-01*2
	3	206-0333-00	174-0977-00	N/A	N/A
P6109B	2	N/A	N/A	N/A	131-4997-01*2
P6111B	2	N/A	N/A	N/A	131-4997-01*2
P6112	2	N/A	N/A	N/A	131-4997-01*2
P6113B	2	N/A	N/A	N/A	131-4997-01*2
P6117	2	N/A	N/A	N/A	131-4997-01*2
P6119B	2	N/A	N/A	N/A	131-4997-01*2
P6121	1.5	206-0311-00	174-0967-00	N/A	N/A
P6122	1.5	206-0312-00	174-0967-00	206-0324-01	206-0342-01*2
	2	206-0318-00	174-0968-00	206-0325-01	N/A
	3	206-0318-01	174-0969-00	206-0326-01	N/A
P6129B	2	N/A	N/A	N/A	131-4997-01*2
P6148A	2	N/A	174-0976-00	206-0217-02	206-0339-04*2
P6149A	2	N/A	174-0976-00	206-0217-02	206-0339-04*2
P6201	1.8	N/A	N/A	N/A	206-0200-00*3
P6202A	2	N/A	N/A	N/A	206-0230-03*1
P6203**	1.5	N/A	N/A	N/A	131-4280-00*3
P6204**	1.5	N/A	N/A	206-0390-00	131-4280-00*3
P6205**	1.5	N/A	N/A	N/A	131-4280-00*3
P6206**	1.7	N/A	N/A	N/A	131-4280-00*3
P6243**	1.3	N/A	N/A	N/A	131-5638-11*1
P6245**	1.3	N/A	N/A	N/A	131-5638-11*1
P3010	2	N/A	N/A	N/A	131-4997-01*2
P6420	1	N/A	174-0975-00	206-0236-01	206-0230-03*1
	2	N/A	174-0976-00	206-0236-01	206-0230-03*1
	3	N/A	174-0977-00	206-0236-01	206-0230-03*1
P6561A	1.3	N/A	206-0417-10	N/A	131-5638-11*1
P6562A	1.3	N/A	206-0417-10	N/A	131-5638-11*1
P6563A	1.3	N/A	206-0459-00	N/A	131-5638-11*1

\*1 Probe tips in package of ten.

\*2 Probe hybrid tip assemblies in packages two each.

\*3 Probe hybrid tip assembly in quantities of one.

\*4 131-1685-01 contact for readout and power (P6205, P6217, P6245, P6243, P6231).

► For your local Tektronix representative see the list in the back of this catalog or outside the U.S. call: 1-503-627-1916, inside the U.S. call: 1-800-426-2200.

## Replacement Parts

Passive and Active Probe General Replacement Parts

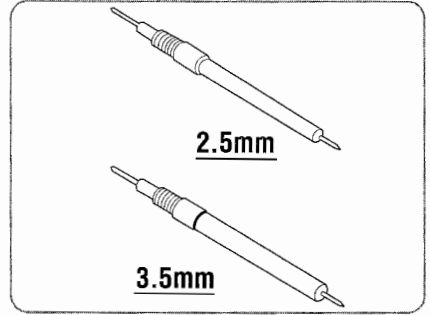
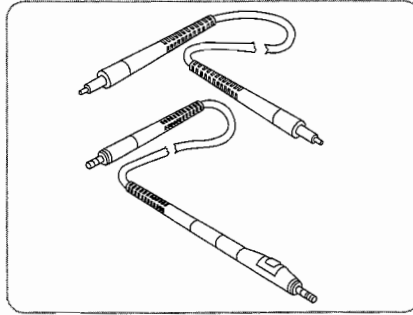
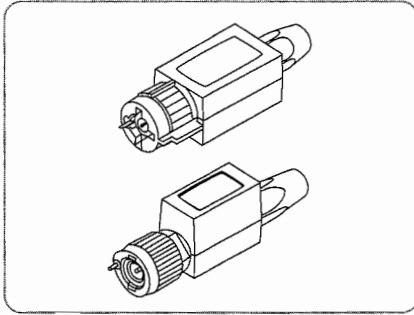

### ► Passive and Active Probe General Replacement Parts (Cont.)

Probe	Length (m)	Connector/Comp. Box	Probe Cable	Probe Tip/Hybrid Tip	Probe Tip/Hybrid Tip Color
P6053C	6	N/A	174-2132-01	N/A	tip-gray/tail-red
Opt. 01	3.5	N/A	174-2133-01	206-0392-00	tip-gray/tail-blue
Opt. 03	9	N/A	174-2134-01	206-0422-02	tip-blue/tail-red
P6130	2	206-0319-00	174-0971-00	N/A	tip-brown/tail-yellow
Opt. 01	1.5	206-0313-00	N/A	N/A	tip-brown/tail-blue
Opt. 03	3	206-0320-00	174-0972-00	N/A	tip-brown/tail-red
P6131	1.3	206-0314-00	174-0973-00	206-0265-10* <sup>2</sup>	tip-clear/tail-blue
Opt. 02	2	206-0321-00	174-0971-00	206-0265-12* <sup>2</sup>	tip-clear/tail-yellow
Opt. 03	3	206-0322-00	174-0972-00	N/A	tip-clear/tail-red
P6133	2	206-0350-00	174-0971-00	206-0265-12* <sup>2</sup>	tip-clear/tail-yellow
Opt. 01	1.3	206-0349-00	174-0973-00	206-0265-13* <sup>2</sup>	tip-clear/tail-clear
Opt. 03	3	N/A	174-0972-00	N/A	tip-clear/tail-red
Opt. 25	1.3	206-0349-00	174-0973-00	206-0393-00* <sup>2</sup>	tip-clear/tail-natural
P6134C	1.5	206-0420-00	174-1081-04	206-0418-00* <sup>2</sup>	tip-black/tail-red
P6135A (13 to 17pF)* <sup>4</sup>	1.5	N/A	N/A	206-0416-00* <sup>3</sup>	tip-red/tail-natural
(18 to 22pF)* <sup>4</sup>	1.5	N/A	N/A	206-0419-00* <sup>3</sup>	tip-black/tail-yellow
(45 to 49pF)* <sup>4</sup>	1.5	N/A	N/A	206-0415-00* <sup>3</sup>	tip-blue/tail-natural
P6136	1.3	206-0359-00	174-0978-00	206-0265-10* <sup>2</sup>	tip-clear/tail-blue
Opt. 25	1.3	206-0359-00	174-0978-00	206-0392-00* <sup>2</sup>	tip-gray/tail-blue
P6137	1.5	206-0389-01	174-1081-04	206-0378-00* <sup>2</sup>	tip-black/tail-natural
P6138	1.3	N/A	174-0978-00	206-0392-00* <sup>2</sup>	tip-gray/tail-blue
P6138A	1.3	N/A	174-3649-00	206-0392-00* <sup>2</sup>	tip-gray/tail-blue
P6139A	1.3	206-0440-00	174-0978-00	206-0441-00* <sup>2</sup>	tip-blue/tail-yellow
P6150 (10X)	1	N/A	174-1341-00	206-0399-03* <sup>2</sup>	N/A
(1X)	1	N/A	174-1341-00	206-0398-00* <sup>2</sup>	N/A
P6156 (10X)	1.5	N/A	174-1127-00	206-0380-00* <sup>2</sup>	tip-blue/tail-black
Opt. 25 adds 100X tip		N/A	N/A	N/A	tip-red/tail-black
20X tip		N/A	N/A	206-0381-00* <sup>2</sup>	tip-gray/tail-black
P6158	1.2	N/A	174-3889-00	206-0381-00* <sup>2</sup>	tip-gray/tail-black
P6230	1.6	N/A	N/A	N/A	tip-yellow/tail-blue
P6231* <sup>5</sup>	1.5	N/A	N/A	N/A	tip-yellow/tail-blue
P6339A	1.3	206-0485-00	174-0978-00	206-0441-00* <sup>2</sup>	tip-blue/tail-yellow

\*1 Not pictured above.

\*2 Probe hybrid tip assembly in quantities of one.

\*3 Consists of a matched pair.

\*4 Scope Input Capacitance Range.

\*5 131-1685-01 contact for readout and power (P6205, P6217, P6245, P6243, P6231).

► For your local Tektronix representative see the list in the back of this catalog or outside the U.S. call: 1-503-627-1916, inside the U.S. call: 1-800-426-2200.